

Presentation



LR97 D ●●●●●



LT47 60 ●●●●●

LR97 D and LT47 electronic over current relays have been developed to satisfy machine protection requirements. These relays have definite time characteristics: current threshold and time based function. They are particularly recommended for providing mechanical protection on machines with high resistive torque, high inertia and with strong probability of jamming under steady state conditions. They can be used for motor protection in the case of long starting times or frequent starting. The LR97 D relay also incorporates two fixed time protection functions, one of 0.5 seconds against locked rotor and one of 3 seconds against phase failure. LR97 D and LT47 can be used to provide mechanical shock protection. In this case, setting the O-Time knob to minimum will ensure tripping in 0.3 seconds.

Applications

- LR97 D and LT47 relays are particularly suitable for the following machines:
- Monitoring function for excessively long starting time on machines with a risk of difficult starting:
 - Machines with high resistive torque, high inertia machines.
 - Monitoring of machines during steady state operation: overtorque detection function
 - Machines with strong risk of jamming, machines with torque build-up over time,
 - Mechanical failure monitoring,
 - Faster detection of malfunctioning on machines where the motor is oversized in relation to its thermal protection I_{th}.
 - Motor protection for specific applications:
 - Machines with long starting times,
 - Machines with high on-load factor: more than 30 to 50 starts/hour,
 - Machine with fluctuating load from a steady state, where the thermal image of a thermal overload relay (thermal memory) is unsuitable in relation to actual overheating of the motor.

Examples of machines:

- Conveyors, crushers and mixers,
- Fans, pumps and compressors,
- Centrifuges and spin-dryers,
- Presses, shearing machines, saws, broaching machines, sanders and lifting hoists.

Operation

Because of their two separate time settings, LR97 D and LT47 relays can be combined with the motor-starter function:

D-Time: starting time, O-Time: trip time during steady state. The D-Time function is only available during the motor starting phase. During this phase the overload detection function is inhibited in order to allow starting. Under steady state conditions, when the motor current is greater than the setting current due to an overload or single-phasing, the red LED lights up and the internal relay switches its contact after a time preset by the O-Time knob.

The red LED stays on, indicating that the relay has tripped.

The relays are simple to set, in 5 easy steps:

- Adjust the 3 knobs to maximum (Load, D-Time and O-Time),
- Adjust the D-Time knob to the value corresponding to the motor starting time.
- When the motor reaches steady state, adjust the Load knob (turn the knob counter-clockwise until the red LED starts to flicker).
- Slowly turn the Load knob clockwise until the LED goes out.
- Set the required tripping time, using the O-Time knob.

Description

Description

LR97 D ●●●●●

LT47 ●●●●●

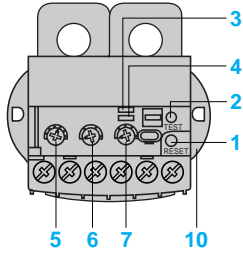
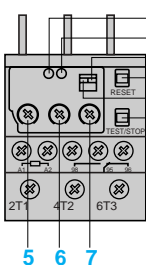

- 1 RESET knob
- 2 TEST/STOP knob
- 3 Ready/Run Indicator
- 4 Relay tripped indicator
- 5 Current setting
- 6 Adjustment of starting time
- 7 Adjustment of tripping time
- 8 Manual/Auto adjustment
- 9 Single-phase/3-phase adjustment
- 10 Retractable fixing lugs

Status signalling

LR97 D ●●●●●

LT47 ●●●●●

To assist fast diagnostics, two LEDs (one green and one red) allow signalling of the operating status:

Status	LED signal	
	Green LED	Red LED
Voltage	On	Off
Starting		
Steady state	On	Off
Overload	On	
Trip	Over-current	Off
	Rotor locked	Off
	Phase failure	Off
	L1	Off
	L2	Off
	L3	Off

Condition	LED signal	
	Green LED	Red LED
Voltage	On	Off
Starting		
Steady state	On	Off
Overload	On	
Trip	Off	On

LR97D

Overload protection Protection against locked rotor and mechanical jamming under steady state conditions

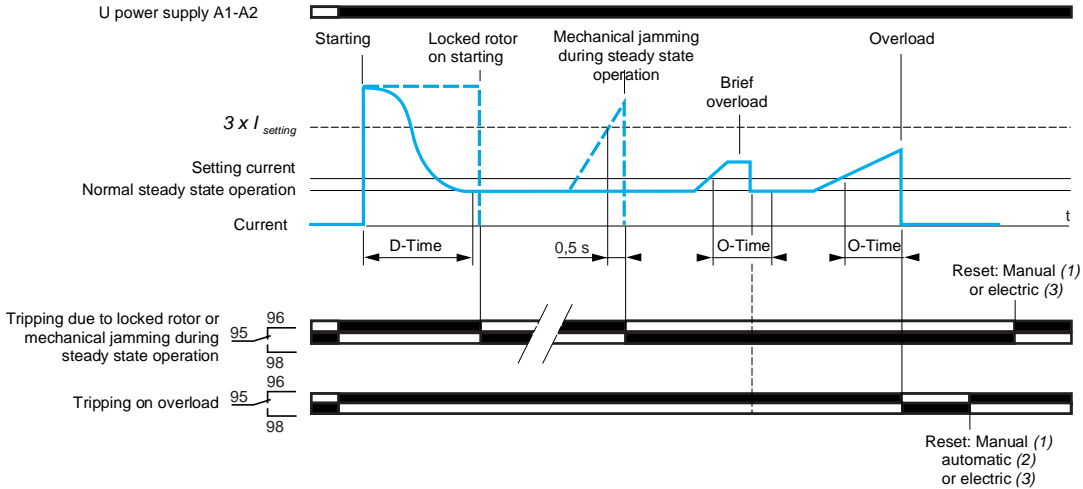

Overload protection Protection against phase failure during starting and during steady state operation

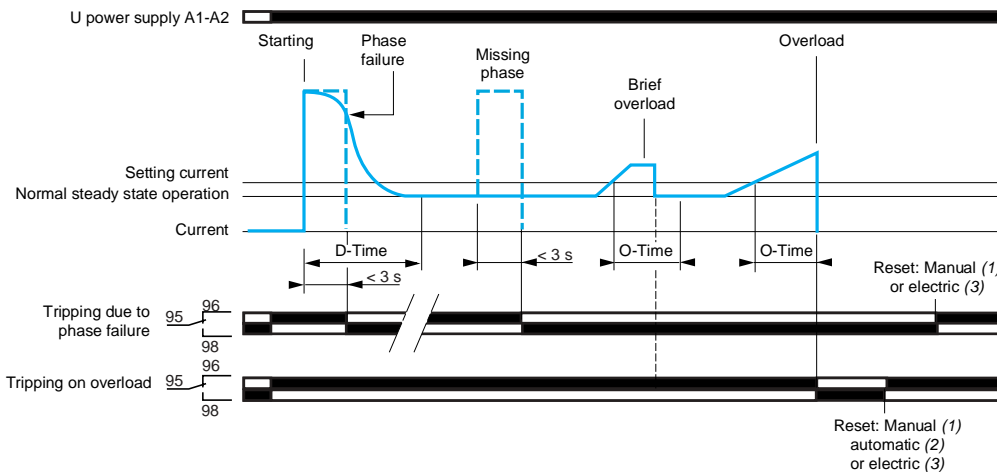

Mechanical shock protection

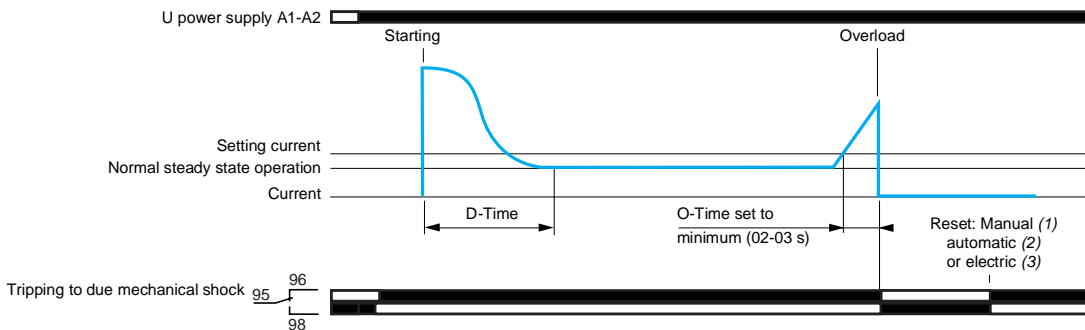

(1) By Reset button.

(2) Fixed time of 120 s. Selectable by dip switch. Function not available in the event of tripping due to locked rotor/mechanical jamming ($I > 3 \times I_{setting}$) or phase failure.

(3) By brief interruption of power supply, minimum 0.1 s.

Curves

LT47

Overload protection

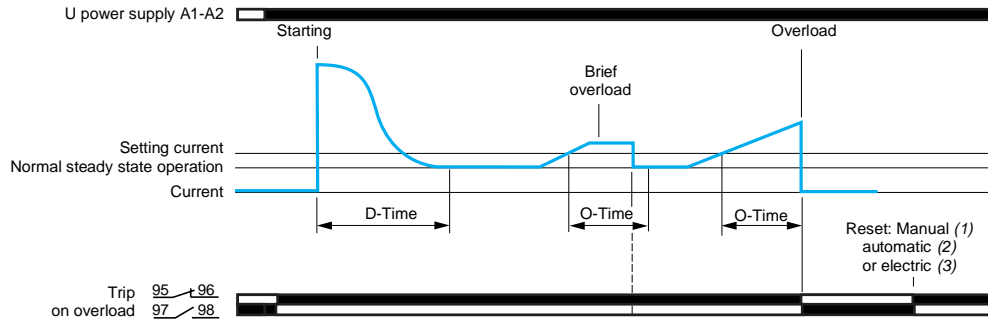

Mechanical shock protection

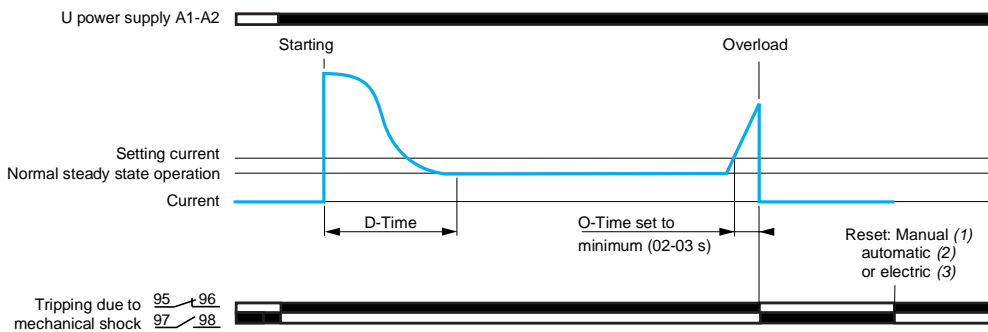

- (1) By Reset button.
- (2) Only available on version with automatic reset (LT47 ●●●●A). Time adjustable from 1 to 120 s with the R-Time knob.
- (3) By brief interruption of power supply, minimum 0.1 s.

Characteristics

Environment

Relay type		LR97 D●●●●●	LT47 ●●●●●
Conforming to standards		IEC 60255-6, IEC 60947	IEC 60255-6, IEC 60947
Product certifications		UL, CSA (pending)	UL, CSA (pending)
Degree of protection	Conforming to IEC 60529 and VDE 0106	IP 20 (front face)	IP 20 (front face)
Protective treatment		"TH"	"TH"
Ambient air temperature around the device	Storage	°C - 30...+ 80	- 30...+ 80
	Normal operation without derating (IEC 60947-4-1)	°C - 25...+ 60	- 25...+ 60
Maximum operating altitude	m	2000	2000
Operating positions without derating	In relation to normal vertical mounting plane	Any position	Any position
Shock resistance	Permissible acceleration conforming to IEC 60068-2-7	15 gn - 11 ms	15 gn - 11 ms
Vibration resistance	Permissible acceleration conforming to IEC 60068-2-6	4 gn	4 gn
Dielectric strength at 50 Hz	Conforming to IEC 60255-5	kV 2	2
Surge withstand	Conforming to IEC 61000-4-5	kV 6	6
Resistance to electrostatic discharge	In open air	kV 8 (level 3)	8 (level 3)
	In direct mode	kV 6 (level 3)	6 (level 3)
Immunity to radiated radio-frequency disturbance		V/m 10 (level 3)	10 (level 3)
Immunity to fast transient currents		kV 2	2
Conducted emissions	Conforming to EN 55011	Class A	Class A
Conducted HF disturbance	Conforming to EN 61000-4-6	V 10	10

Characteristics

Auxiliary contact characteristics

Relay type		LR97 D●●●●●				LT47 ●●●●●					
Contact type		1 NO/NC				1 N/O + 1N/C					
Conventional thermal current		A	3				3				
Maximum hold consumption of controlled contactor coils (occasional operating cycles of contact 95-96)	Conforming to IEC 947	V	~ 24	~ 48	~ 110	~ 220	~ 24	~ 48	~ 110	~ 220	
		VA	70	140	360	360	70	140	360	360	
		V	--- 24	--- 48	--- 110	--- 220	--- 24	--- 48	--- 110	--- 220	
		W	55	55	28	28	55	55	28	28	
Short-circuit protection		A	3				3				
Connection by cable or lug-clamps											
Flexible cable without cable end	1 or 2 conductors	Min.	mm²	1 x 0.75				1 x 1			
		Max.	mm²	2 x 2.5				2 x 2.5			
Flexible cable with cable end	1 or 2 conductors	Min.	mm²	1 x 0.34				1 x 1			
		Max.	mm²	1 x 1.5 + 1 x 2.5				2 x 2.5			
External Ø of lugs				mm				7			
Ø of screw				mm				M3			
Tightening torque				N.m				0.6...1.2			

Electrical characteristics of power circuit

Relay type		LR97 D015●● to LR97 D25●●		LR97 D38●●	LT47 ●●●●●		
Setting range	Depending on model	A	0.5...38		0.3...60		
Tripping class		Adjustable			Adjustable		
Rated insulation voltage (Ui)	Conforming to IEC 60947-4-1	V	690		690		
	Conforming to UL, CSA	V	600		600		
Rated impulse withstand voltage (Uimp)		kV	6		6		
Frequency limits	Of the operating current	Hz	50...60		50...60		
Connection by cable or lug-clamps							
Flexible cable without cable end	1 conductor	Min.	mm²	1.5	2.5	–	
		Max.	mm²	10	10	–	
Flexible cable with cable end	1 conductor	Min.	mm²	1	1	–	
		Max.	mm²	4	6	–	
External Ø of lugs				mm	10	12	–
Ø of screw				mm	M4	M4	–
Tightening torque				N.m	2	2	–

Operating characteristics

Relay type		LR97 D●●●●●		LT47 ●●●●S	LT47 ●●●●A	
Adjustment	Current	A	"Load" knob		"Load" knob	
	Time	D-time knob	s	0.5...30	0.5...30	–
		O-time knob	s	0.2/0.3...10	0.2/0.3...10	0.2/0.3...30
		R-time knob	s	–	–	1...120
Reset	Manual	Reset button		Reset button	Reset button	
	Automatic	120 s fixed		–	R-time knob: 1-120 s	
	Electrical	By interruption of power supply (minimum 0.1 s)		By interruption of power supply (minimum 0.1 s)	By interruption of power supply (minimum 0.1 s)	
Protection functions				On starting	Steady state	–
Overload $I_{max} > I_{setting}$	Tripping			Inhibited during D-time	After O-time	After O-time
				After D-time	< 0.5 s	After O-time
Locked rotor, mechanical jamming $I > 3 \times I_{setting}$	Tripping			Inhibited during D-time	After O-time	After O-time
				After D-time	< 0.5 s	After O-time
Sensitivity to phase failure	Tripping			Inhibited during D-time	After O-time	After O-time
				< 3 s	< 3 s	After O-time
Status and fault signalling (see table page 24517/2)				2 LEDs		2 LEDs
TEST/STOP function	Test			No load		No load
	Stop			Under load		Under load
Sealing				Yes		Yes



LR97 D●●●●●



LT47 60●●●

LR97 D electronic over current relays

Relay setting range	Usable range (1)	For use with contactor (2)	Relay supply voltage	Reference	Weight
A	A				kg
0.3...1.5	0.3...1.3	LC1 D09...D38	~ 220 V	LR97 D015M7	0.172
			~ 110 V	LR97 D015F7	0.172
			~/~ 24 V	LR97 D015B	0.172
			~/~ 48 V	LR97 D015E	0.172
1.2...7	1.2...6	LC1 D09...D38	~ 220 V	LR97 D07M7	0.172
			~ 110 V	LR97 D07F7	0.172
			~/~ 24 V	LR97 D07B	0.172
			~/~ 48 V	LR97 D07E	0.172
5...25	5...21	LC1 D09...D38	~ 220 V	LR97 D25M7	0.172
			~ 110 V	LR97 D25F7	0.172
			~/~ 24 V	LR97 D25B	0.172
			~/~ 48 V	LR97 D25E	0.172
20...38	20...34	LC1 D25...D38	~ 220 V	LR97 D38M7	0.172
			~ 110 V	LR97 D38F7	0.172
			~/~ 24 V	LR97 D38B	0.172
			~/~ 48 V	LR97 D38E	0.172

LT47 electronic over current relays

Relay setting range	Usable range (1)	Relay supply voltage	Reference (3)	Weight
A	A			kg
LT47 relay with manual/electric reset				
0.5...6	0.5...5	~ 220 V	LT47 06M7S	0.192
		~ 110 V	LT47 06F7S	0.192
		~/~ 24 V	LT47 06BS	0.192
		~/~ 48 V	LT47 06ES	0.192
3...30	3...25	~ 220 V	LT47 30M7S	0.192
		~ 110 V	LT47 30F7S	0.192
		~/~ 24 V	LT47 30BS	0.192
		~/~ 48 V	LT47 30ES	0.192
5...60	5...50	~ 220 V	LT47 60M7S	0.192
		~ 110 V	LT47 60F7S	0.192
		~/~ 24 V	LT47 60BS	0.192
		~/~ 48 V	LT47 60ES	0.192
LT47 relay with automatic reset				
0.5...6	0.5...5	~ 220 V	LT47 06M7A	0.192
		~ 110 V	LT47 06F7A	0.192
		~/~ 24 V	LT47 06BA	0.192
		~/~ 48 V	LT47 06EA	0.192
3...30	3...25	~ 220 V	LT47 30M7A	0.192
		~ 110 V	LT47 30F7A	0.192
		~/~ 24 V	LT47 30BA	0.192
		~/~ 48 V	LT47 30EA	0.192
5...60	5...50	~ 220 V	LT47 60M7A	0.192
		~ 110 V	LT47 60F7A	0.192
		~/~ 24 V	LT47 60BA	0.192
		~/~ 48 V	LT47 60EA	0.192

Accessories (to be ordered separately)

Description	For use with	Sold in lots of	Unit reference	Weight
				kg
Pre-wiring kits allowing connection of the LR97 D relay N/C contact directly to the contactor	LC1 D09...D18	10	LAD 7C1	0.002
	LC1 D25...D38	10	LAD 7C2	0.003
Terminal block for clip-on mounting on 35 mm rail (AM1 DP200)	LR97 D	1	LAD 7B10	0.100

(1) To allow adjustment of the tripping sensitivity, see adjustment method (page 24517/2).

(2) Please see our "Motor starter solutions" catalogue.

(3) If a pre-wiring kit is used, it is no longer possible to electrically wire signalling of tripped status.

Dimensions

LR97 D●●●●

LT47 ●●●●

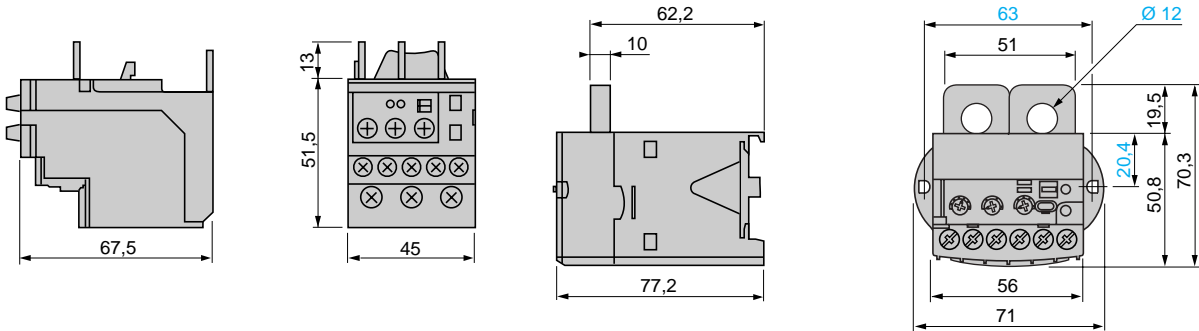

Mounting

LR97 D●●●●

LT47 ●●●●

Direct mounting beneath the contactor

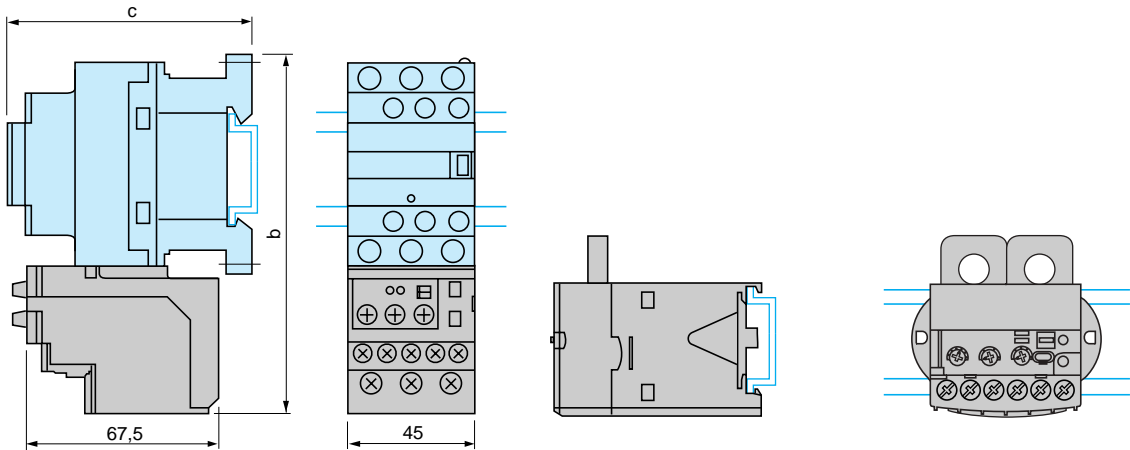

	D09...D18	D25...D38
b	123	137
c	See pages 24531/2 and 24531/3	

Note: Can be mounted on rail.

Schemes

LR97 D●●●●

LT47 ●●●●

