

---

<i>Presentation</i>	6
<i>Functions and characteristics</i>	13
<i>Dimensions and connection</i>	57
<b>Compact NS100 to 630</b>	<b>82</b>
Indication contacts	82
Motor mechanism (automatic reset)	84
Motor mechanism (remote reset)	86
Motor mechanism (local reset)	88
Early-make contacts	90
<b>Masterpact NW10 to NW40 DC</b>	<b>91</b>
Fixed and drawout devices	91
Communication option 24 V DC external power supply	93
<i>Installation recommendations</i>	95
<i>Additional characteristics</i>	113
<i>Catalogue numbers and order form</i>	135

The diagram is shown with circuits de-energised, all devices open, connected and charged and relays in the normal position.

### Compact NS100 to NS250

#### Manually operated circuit breaker

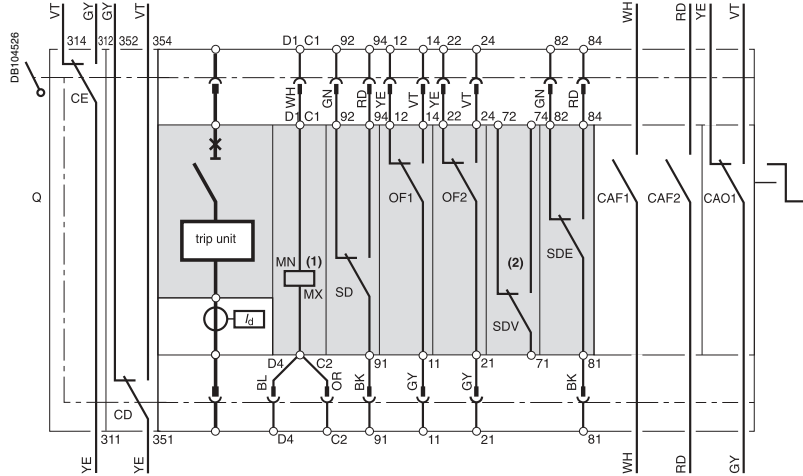

(1) MN or MX (MN: D1, D4; MX: C1, C2).

(2) For the withdrawable and plug-in versions, SDV and OF2 contacts can be installed in the circuit breaker, but only one can be connected to the automatic auxiliary connectors.

#### Circuit breaker with motor mechanism

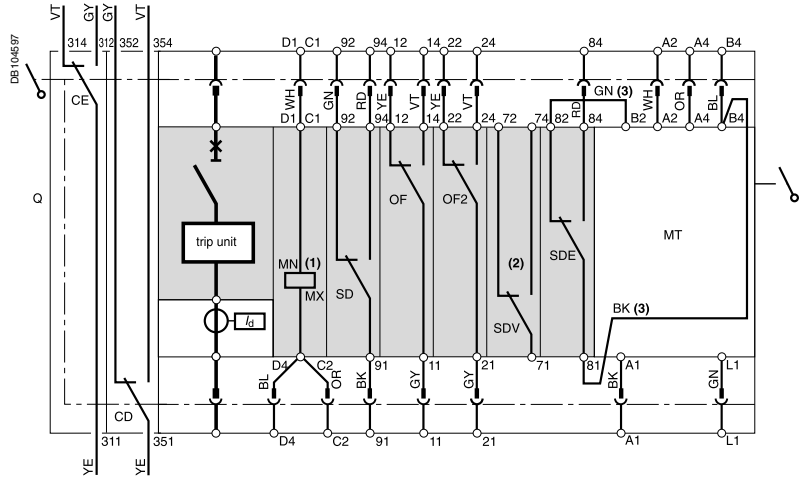

(1) MN or MX (MN: D1, D4; MX: C1, C2).

(2) For the withdrawable and plug-in versions, SDV and OF2 contacts can be installed in the circuit breaker, but only one can be connected to the automatic auxiliary connectors.

(3) Wires supplied, must be connected to ensure correct operation.

#### Symbols

- Q** Compact NS100 to 250
- SD** trip indication contact
- SDE** fault indication contact
- SDV** earth-fault indication contact
- OF** ON / OFF indication contact
- MN** undervoltage release
- MX** shunt release
- MT** motor-mechanism module
- CAO** early-break contact of rotary handle
- CAF** early-make contact of rotary handle
- CE** connected-position carriage switch
- CD** disconnected-position carriage switch.

#### Colour code for auxiliary wiring

- RD** red
- GN** green
- BK** black
- VT** violet
- YE** yellow
- GY** grey
- BL** blue
- OR** orange
- WH** white.

#### Auxiliary wiring for plug-in / withdrawable circuit breaker

**Automatic auxiliary connectors**  
(wires 0.75 to 2.5 mm<sup>2</sup>)

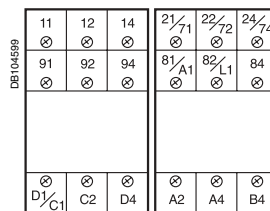

Fixed part (front view looking into base).

**Manual auxiliary connectors**  
(wires 0.75 to 2.5 mm<sup>2</sup>)

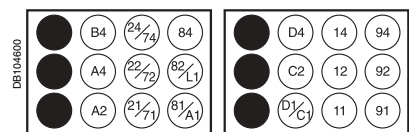

Fixed part (rear view).

## Compact NS400 to NS630

### Manually operated circuit breaker

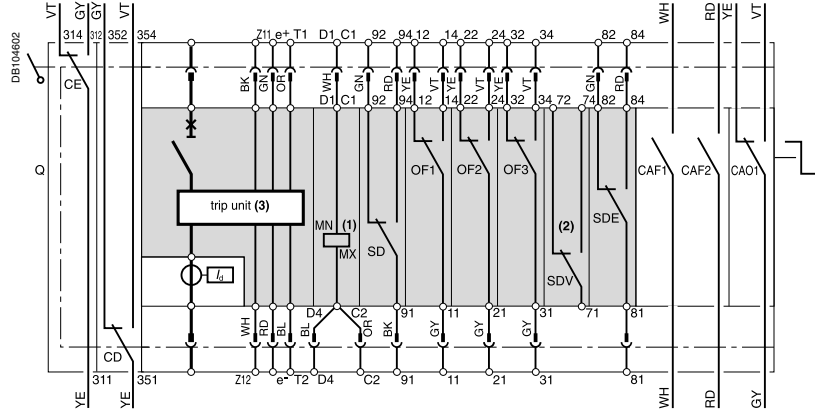

(1) MN or MX (MN: D1, D4; MX: C1, C2).

(2) For the withdrawable and plug-in versions, SDV and OF2 contacts can be installed in the circuit breaker, but only one can be connected to the automatic auxiliary connectors.

(3) Options available with trip unit STR53UE only.

### Circuit breaker with motor mechanism

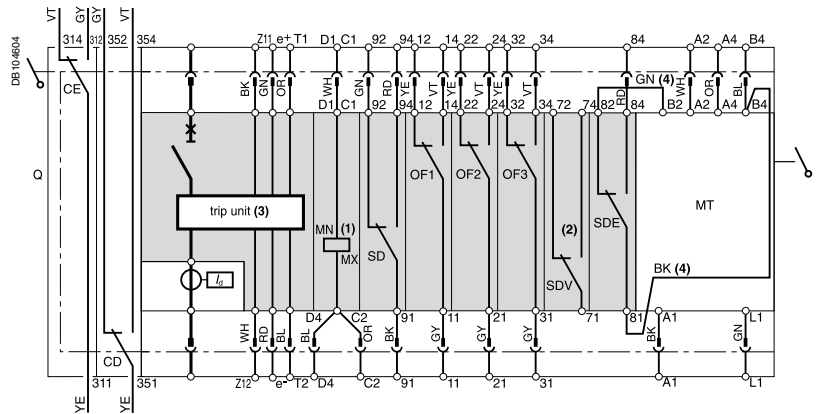

(1) MN or MX (MN: D1, D4; MX: C1, C2).

(2) For the withdrawable and plug-in versions, SDV and OF2 contacts can be installed in the circuit breaker, but only one can be connected to the automatic auxiliary connectors.

(3) Options available with trip unit STR53UE only.

(4) Wires supplied, must be connected to ensure correct operation.

### Auxiliary wiring for plug-in / withdrawable circuit breaker

**Automatic auxiliary connectors**  
(wires 0.75 to 2.5 mm<sup>2</sup>)

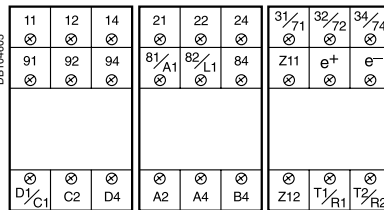

Fixed part (front view looking into base).

**Manual auxiliary connectors**  
(wires 0.75 to 2.5 mm<sup>2</sup>)

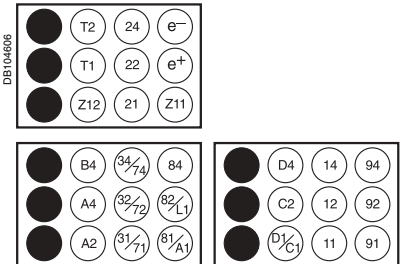

Fixed part (rear view).

#### Symbols

- Q** Compact NS100 to 250
- SD** trip indication contact
- SDE** fault indication contact
- SDV** earth-fault indication contact
- OF** ON / OFF indication contact
- MN** undervoltage release
- MX** shunt release
- MT** motor-mechanism module
- CAO** early-break contact of rotary handle
- CAF** early-make contact of rotary handle
- CE** connected-position carriage switch
- CD** disconnected-position carriage switch.

#### Colour code for auxiliary wiring

- RD** red
- GN** green
- BK** black
- VT** violet
- YE** yellow
- GY** grey
- BL** blue
- OR** orange
- WH** white.

The diagram is shown with circuits de-energised, all devices open, connected and charged and relays in the normal position.

Following tripping due to an electrical fault, reset must be carried out locally and manually.

### Automatic reset with MN

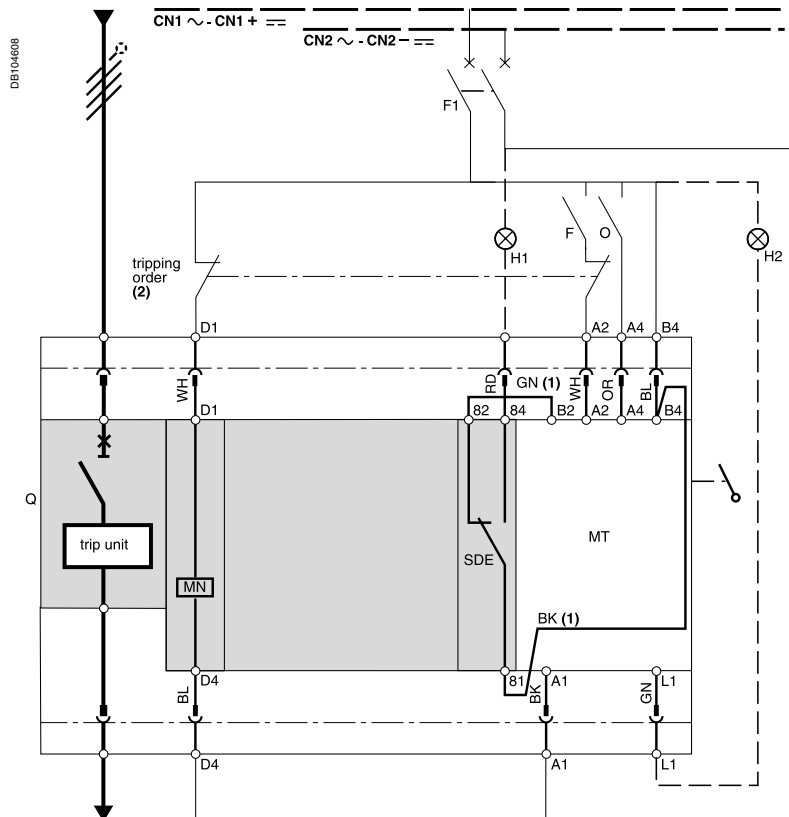

- (1) Wires supplied, must be connected to ensure correct operation.
- (2) The tripping order must lock out the closing order.

### Automatic reset with MX

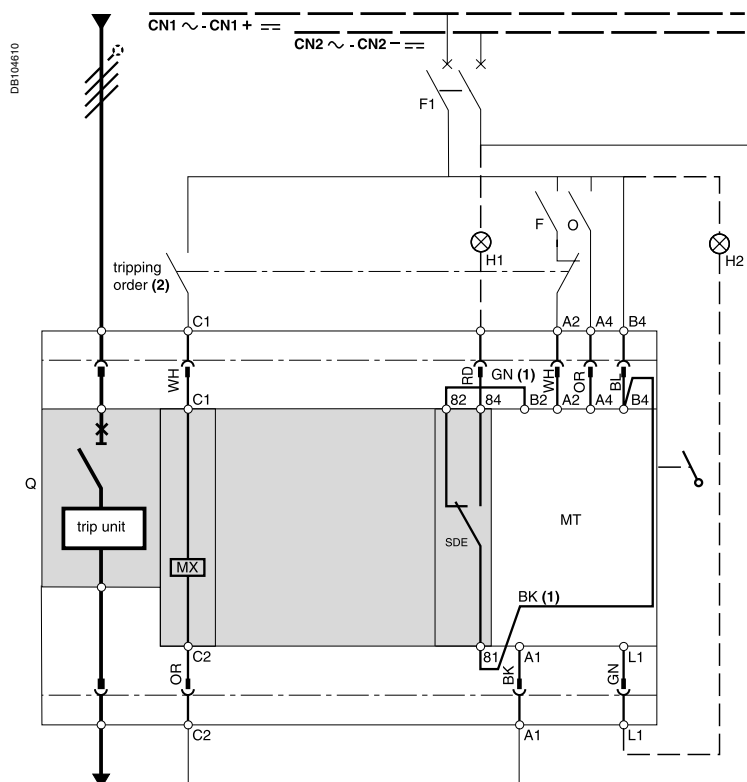

- (1) Wires supplied, must be connected to ensure correct operation.
- (2) The tripping order must lock out the closing order.

#### Symbols

- Q** Compact NS100 to 630
  - SDE** fault indication contact
  - MT** motor-mechanism module
  - F1** breaker for protection of motor-mechanism module circuits
  - H1** lamp signalling an electrical fault
  - H2** lamp signalling motor mechanism in manual position
  - F** closing order
  - O** opening order
- orders must not be simultaneous
- Colour code for auxiliary wiring**
- RD** red
  - GN** green
  - BK** black
  - BL** blue
  - OR** orange
  - WH** white.

### Automatic reset without auxiliary

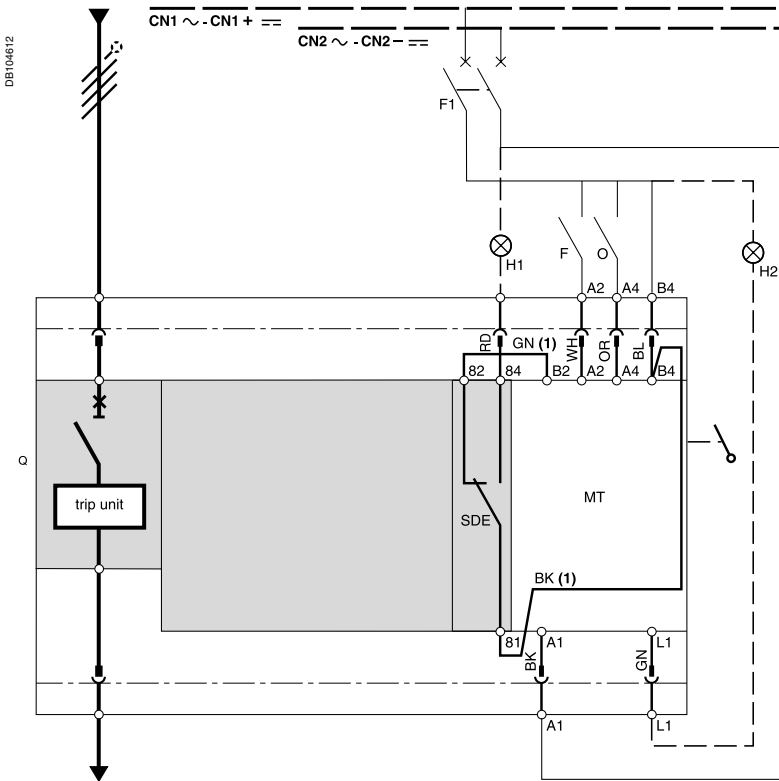

(1) Wires supplied, must be connected to ensure correct operation.

### Control via switch or relay

With MN/MX

Controlled by switch

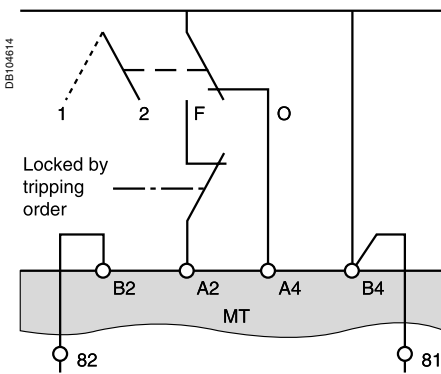

Controlled by relay

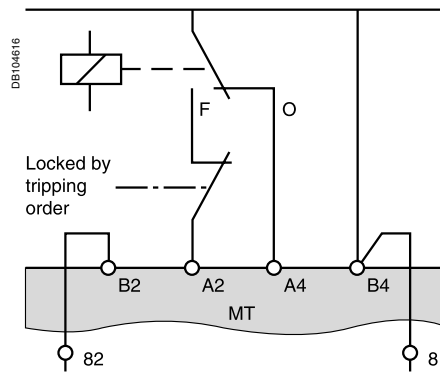

Without auxiliary

Controlled by switch

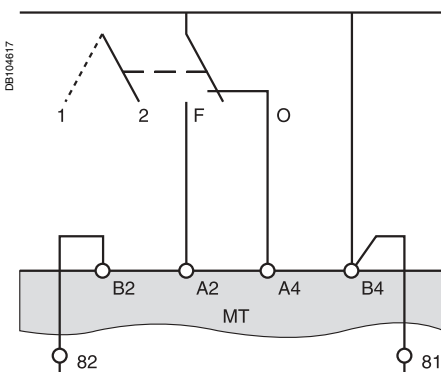

Controlled by relay

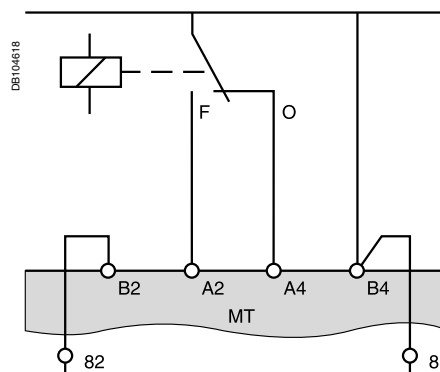

The diagram is shown with circuits de-energised, all devices open, connected and charged and relays in the normal position.

Following tripping due to an electrical fault, reset must be carried out locally and manually.

### Remote reset with MN

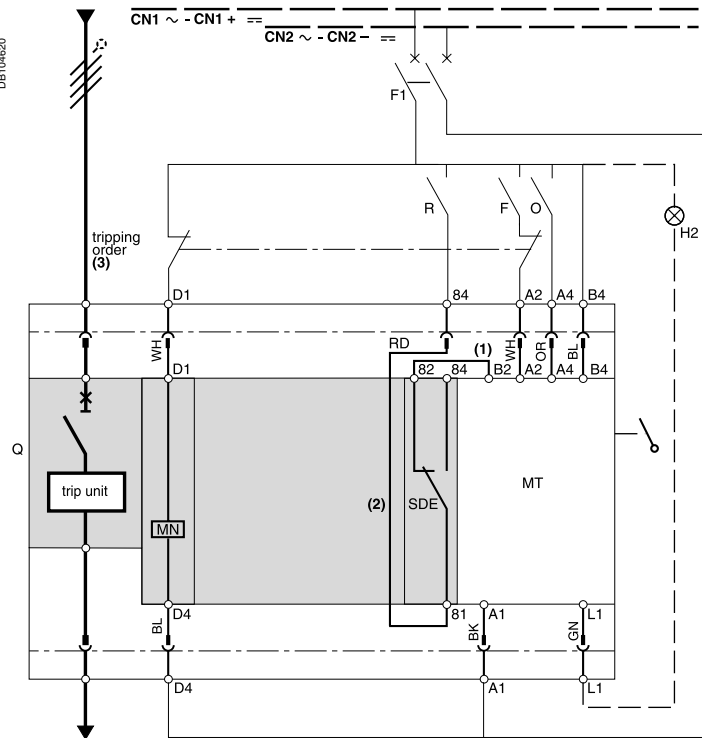

- (1) Wires supplied, must be connected to ensure correct operation.
- (2) Connect SDE terminal 81 to auxiliary-connector terminal 84.
- (3) The tripping order must lock out the closing order.

### Remote reset with MX

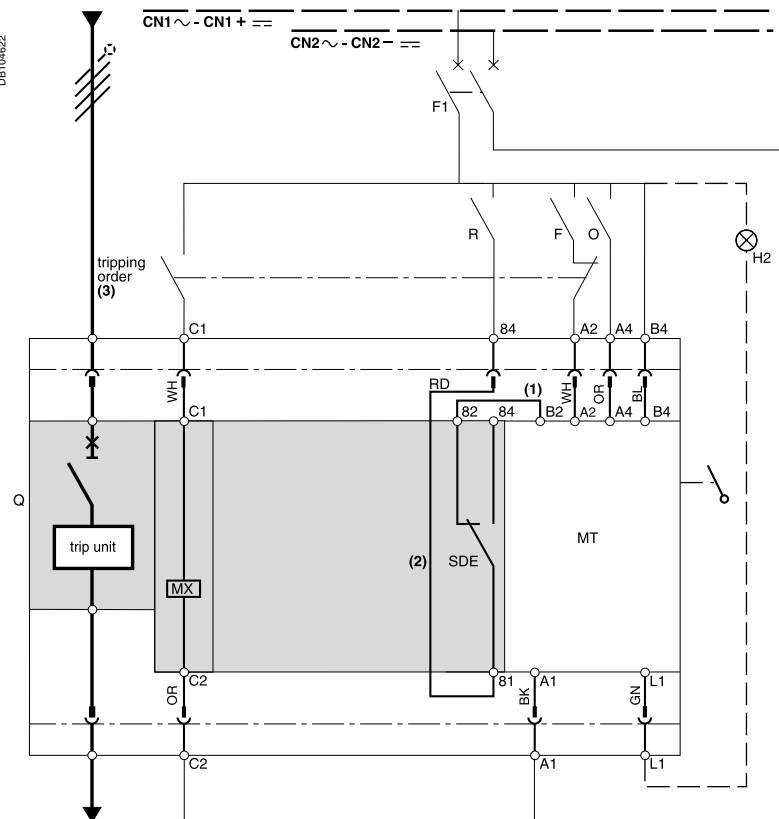

- (1) Wires supplied, must be connected to ensure correct operation.
- (2) Connect SDE terminal 81 to auxiliary-connector terminal 84.
- (3) The tripping order must lock out the closing order.

**Symbols**

- Q** Compact NS100 to 630
  - SDE** fault indication contact
  - MN** undervoltage release
  - MX** shunt release
  - MT** motor-mechanism module
  - F1** breaker for protection of motor-mechanism module circuits and MN/MX
  - H2** lamp signalling motor mechanism in manual position
  - R** reset order (must be > 150 ms)
  - F** closing order
  - O** opening order (must be > 150 ms, has priority over F order).
- orders must not be simultaneous

**Colour code for auxiliary wiring**

- RD** red
- GN** green
- BK** black
- BL** blue
- OR** orange
- WH** white.

### Remote reset without auxiliary

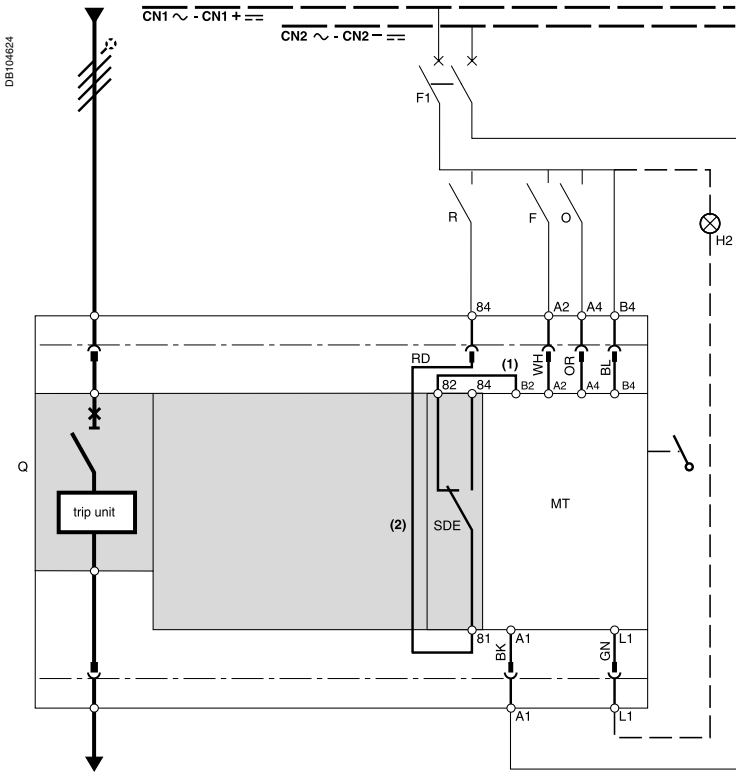

- (1) Wires supplied, must be connected to ensure correct operation.
- (2) Connect SDE terminal 81 to auxiliary-connector terminal 84.

### Control via switch or relay

With MN/MX

Controlled by switch

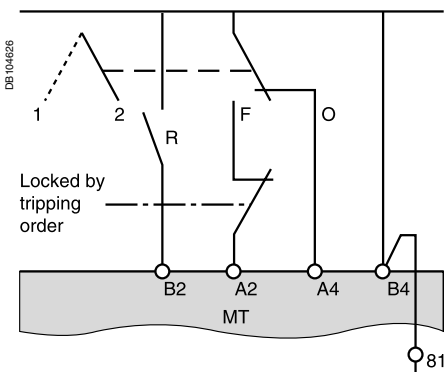

Controlled by relay

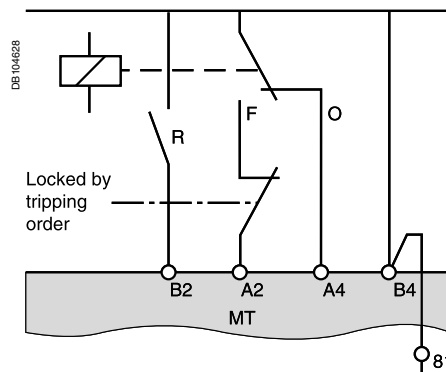

Without auxiliary

Controlled by switch

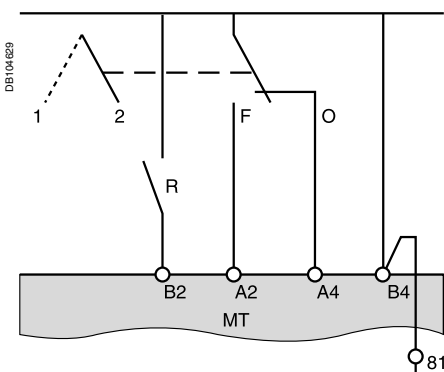

Controlled by relay

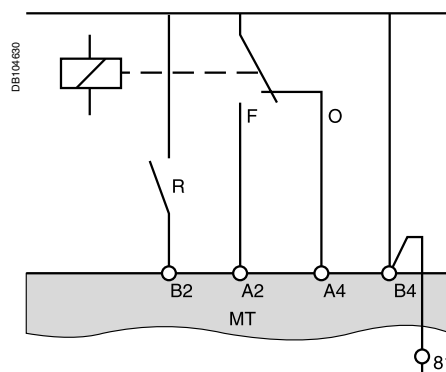

The diagram is shown with circuits de-energised, all devices open, connected and charged and relays in the normal position.

Following tripping due to an electrical fault, reset must be carried out locally and manually.

### Local reset with MN

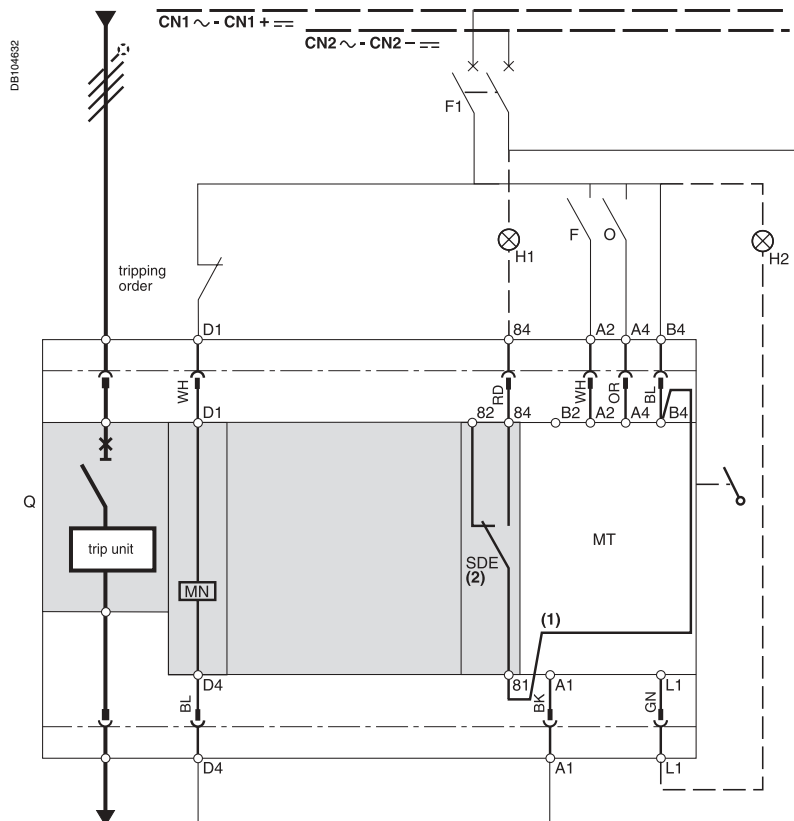

(1) (2) Required to ensure correct indication of an electrical fault.

### Local reset with MX

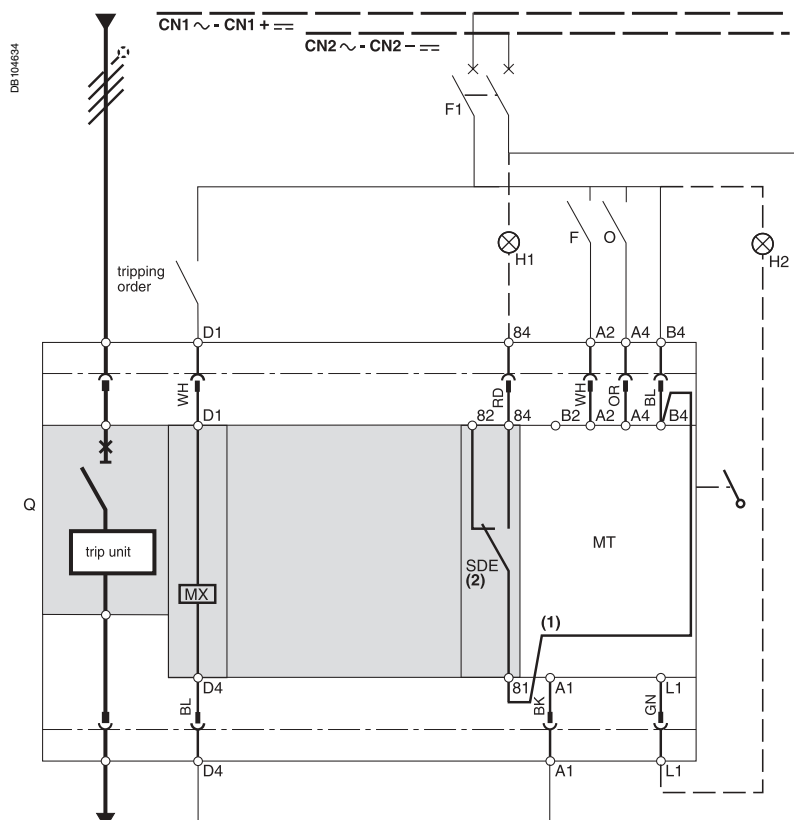

(1) (2) Required to ensure correct indication of an electrical fault.

**Symbols**

- Q** Compact NS100 to 630
  - SDE** fault indication contact
  - MN** undervoltage release
  - MX** hunt release
  - MT** motor-mechanism module
  - F1** breaker for protection of motor-mechanism module circuits and MN/MX
  - H1** lamp signalling an electrical fault
  - H2** lamp signalling motor mechanism in manual position
  - F** closing order
  - O** opening order
- } orders must not be simultaneous  
(must be > 150 ms, has priority over F order).

**Colour code for auxiliary wiring**

- RD** red
- GN** green
- BK** black
- BL** blue
- OR** orange
- WH** white.

### Local reset without auxiliary

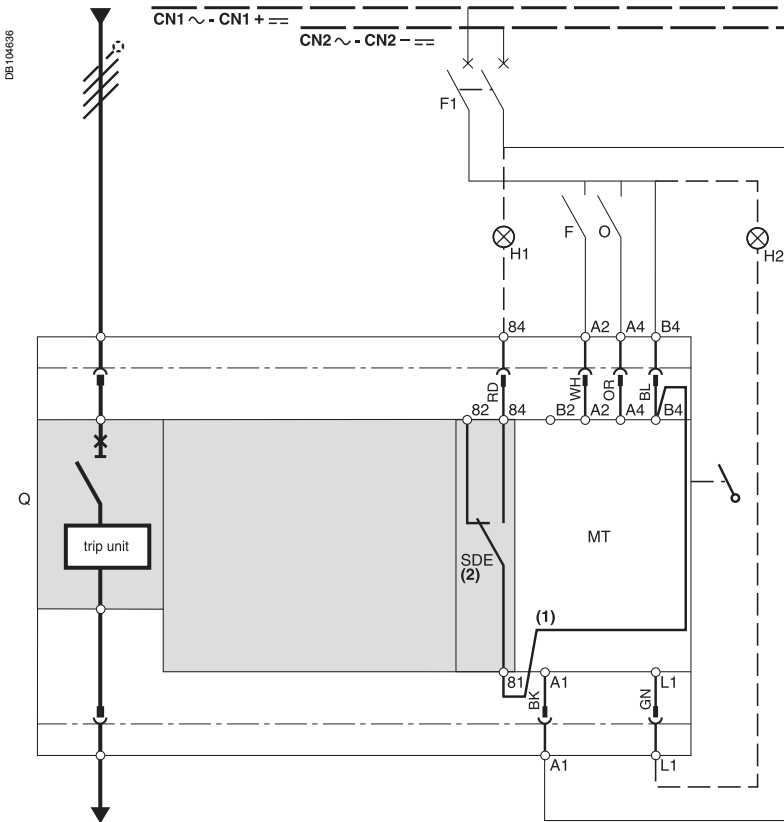

(1) (2) Required to ensure correct indication of an electrical fault.

### Control via switch or relay

With MN/MX

Controlled by switch

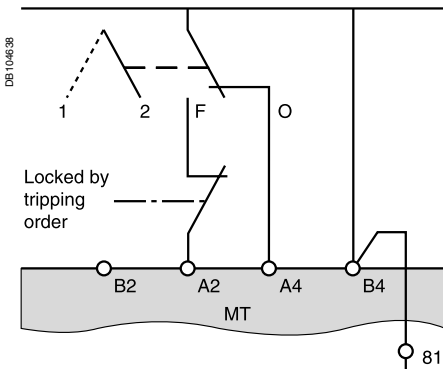

Controlled by relay

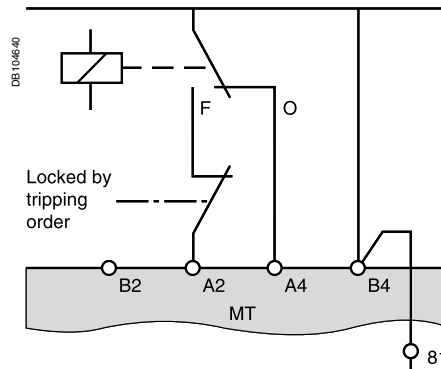

Without auxiliary

Controlled by switch

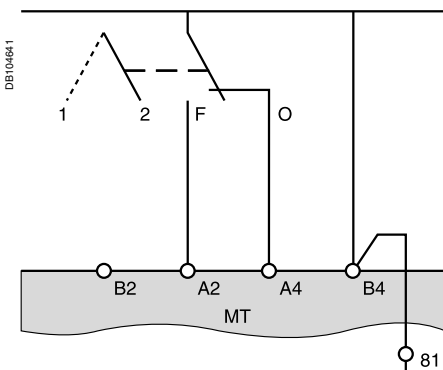

Controlled by relay

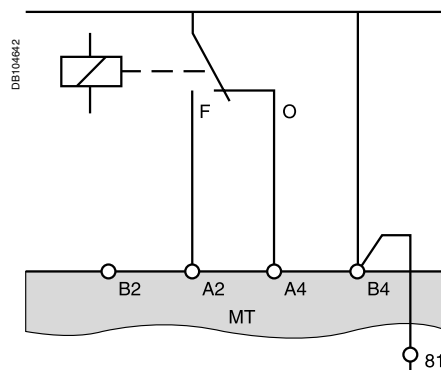



The diagram is shown with circuits de-energised, all devices open, connected and charged and relays in the normal position.

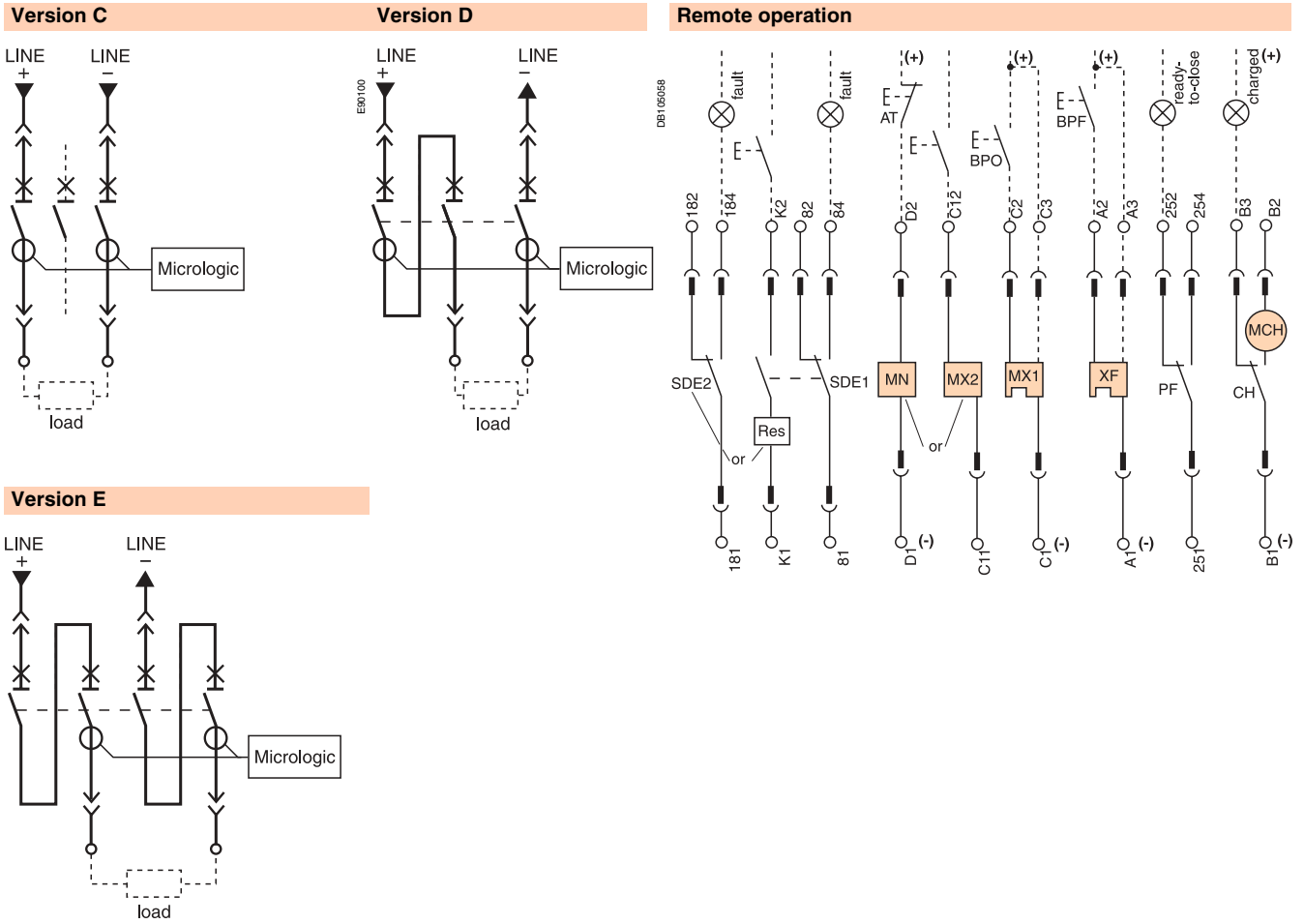

Control unit	
<b>Terminal block marking</b>	<b>Com</b> : E1-E6 communication
	○ ○ E5 E6
	○ ○ E3 E4
	○ ○ E1 E2

Remote operation							
<b>SDE2</b> / <b>Res</b>	<b>SDE1</b>	<b>MN</b> / <b>MX2</b>	<b>MX1</b>	<b>XF</b>	<b>PF</b>	<b>MCH</b>	
○ / ○ 184 / K2	○ 84	○ / ○ D2 / C12	○ C2	○ A2	○ 254	○ B2	
○ 182	○ 82		○ C3	○ A3	○ 252	○ B3	
○ / ○ 181 / K1	○ 81	○ / ○ D1 / C11	○ C1	○ A1	○ 251	○ B1	

- SDE2:** fault-trip indication contact  
or
- Res:** remote reset
- SDE1:** fault-trip indication contact (supplied as standard)
- MN:** undervoltage release  
or
- MX2:** shunt release
- MX1:** shunt release (standard or communicating)
- XF:** closing release (standard or communicating)
- PF:** ready-to-close contact
- MCH:** electric motor

**Note:**  
When communicating MX or XF releases are used, the third wire (C3,A3) must be connected even if the communication module is not installed.

**Indication contacts**

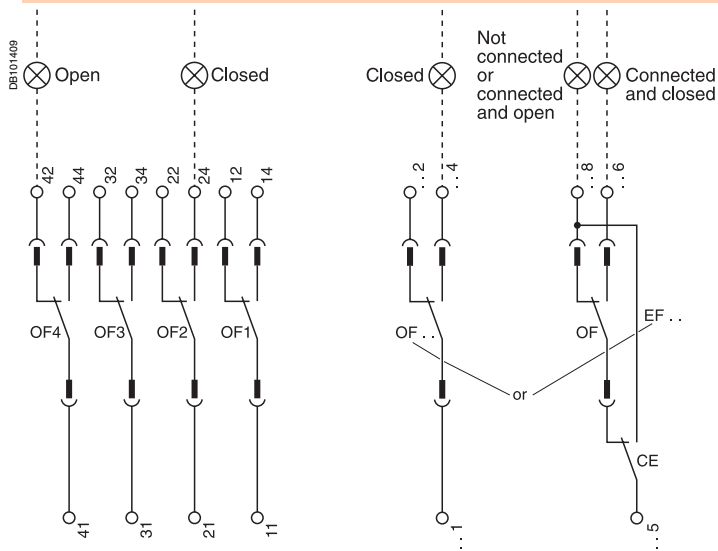

**Chassis contacts**

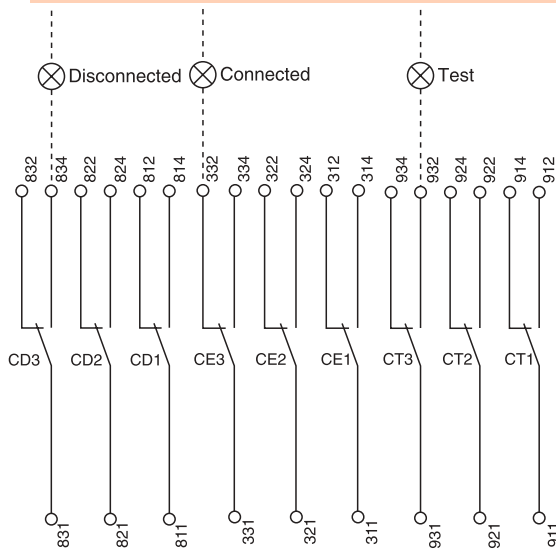

**Indication contacts**

OF4	OF3	OF2	OF1	OF24	OF23	OF22	OF21	OF14	OF13	OF12	OF11
44	34	24	14	244	234	224	214	144	134	124	114
42	32	22	12	242	232	222	212	142	132	122	112
41	31	21	11	241	231	221	211	141	131	121	111
				or	or	or	or	or	or	or	or
EF24	EF23	EF22	EF21	EF14	EF13	EF12	EF11				
248	238	228	218	148	138	128	118				
246	236	226	216	146	136	126	116				
245	235	225	215	145	135	125	115				

**Chassis contacts**

CD3	CD2	CD1	CE3	CE2	CE1	CT3	CT2	CT1
834	824	814	334	324	314	934	924	914
832	822	812	332	322	312	932	922	912
831	821	811	331	321	311	931	921	911
			or				or	
CE6	CE5	CE4				CE9	CE8	CE7
364	354	344				394	384	374
362	352	342				392	382	372
361	351	341				391	381	371

**Indication contacts**

<b>OF4</b>	ON/OFF	<b>OF24</b>	ON/OFF indication contacts
<b>OF3</b>	indication contacts	<b>or</b>	
<b>OF2</b>		<b>EF24</b>	Combined "connected-closed" indication contacts
<b>OF1</b>			
		<b>OF22 or</b>	
		<b>EF22</b>	
		<b>OF21 or</b>	
		<b>EF21</b>	
		<b>OF14 or</b>	
		<b>EF14</b>	
		<b>OF13 or</b>	
		<b>EF13</b>	
		<b>OF12 or</b>	
		<b>EF12</b>	
		<b>OF11 or</b>	
		<b>EF11</b>	

**Chassis contacts**

<b>CD3</b>	Disconnected position contacts	<b>CE3</b>	Connected position contacts	<b>CT3</b>	Test position contacts
<b>CD2</b>		<b>CE2</b>		<b>CT2</b>	
<b>CD1</b>		<b>CE1</b>		<b>CT1</b>	
<b>or</b>					
<b>CE6</b>	Connected position contacts	<b>CE9</b>	Connected position contacts		
<b>CE5</b>		<b>CE8</b>			
<b>CE4</b>		<b>CE7</b>			
<b>or</b>					
<b>CD6</b>	Disconnected position contacts				
<b>CD5</b>					
<b>CD4</b>					

Legend:

Drawout device only.

SDE1, OF1, OF2, OF3, OF4 supplied as standard.

Interconnected connections (only one wire per connection point).

# Masterpact NW10 to NW40 DC Communication option 24 V DC external power supply

## Connection of the communications option

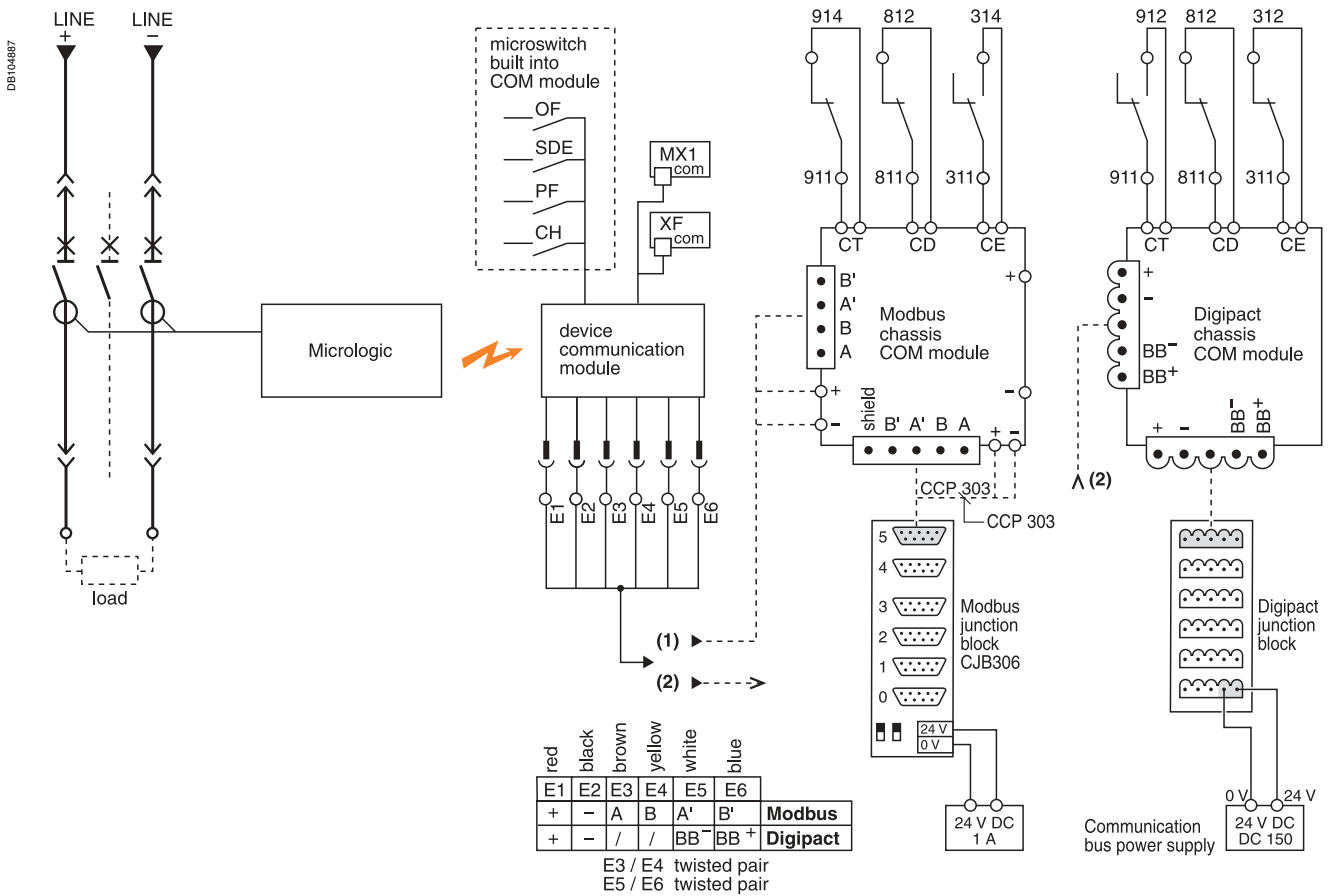

The communications bus requires its own 24 V DC power source (E1, E2).

(1) Drawout device equipped with Modbus chassis COM module.  
(2) Drawout device equipped with Digipact chassis COM module.

# Masterpact NW10 to NW40 DC

## Communication option

### 24 V DC external power supply

#### Examples using the COM communications option

##### Communicating switchboard

This configuration provides remote display and control of Masterpacts equipped with the Modbus or Digipact COM module. The Digipact bus can be combined with the Modbus bus.

